

MTI Instruments Flat Capacitance Probes

Accumeasure™ Capacitance Probes

for

Accumeasure™ D series



MTI Instruments Flat Capacitance Probes for Grounded Targets

MTI's flat capacitance probe series. The thin probes may be used as is or bonded to a flat plate with mounting holes. Applications include single ended and double sided gap measurement such as commutator gaps, automotive and aviation assemblies.



Optionally, probes can be ordered bonded to a flat steel plate with 4X countersunk screw holes for conventional fastener attachment.

General Specifications for Flat Probes

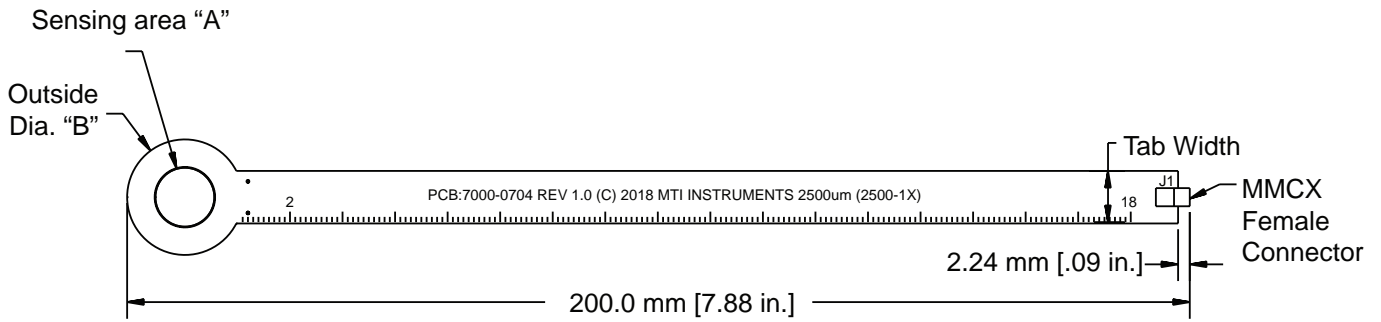

Mounted & Unmounted Probes

PRODUCT CODE	Range		Min. Range		Resolutions at 10Hz RMS		Max Range Extension ¹	Resolutions at 15kHz RMS		Sensing area "A"		Outside Dia. "B"		Tab Width
	µm	mils	µm	mils	nm	µi		nm	µi	mm	Inch	mm	Inch	mm
AFP-250M-CTR/SE*	250	10	12.70	0.50	0.393	0.015	9x	1.373	0.054	3.55	0.139	5.31	0.209	5
AFP-500M-CTR/SE*	500	20	25.40	1.00	0.785	0.031	3x	2.746	0.108	5.02	0.198	7.78	0.306	7
AFP-1250M-CTR/SE*	1250	50	63.50	2.50	1.963	0.077	2x	6.864	0.270	7.93	0.312	13.69	0.539	10
AFP-2500M-CTR/SE*	2500	100	127.00	5.00	3.926	0.155	2x	13.729	0.541	11.22	0.442	20.98	0.826	10
AFP-5000M-CTR/SE*	5000	200	254.00	10.00	7.852	0.309	2x	27.457	1.081	15.86	0.624	36.63	1.442	10

*For mounting plate option, add /T1 after the product code.

Mounted Probe

Dimensions for SS Mounting plates	Plate Length "C"	Plate Width "D"	Mounting Dim. "E"	Mounting Dim. "F"
	mm [inch]	mm [inch]	mm [inch]	mm [inch]
250M	15.49 [0.610]	10.69 [0.421]	12.83 [0.505]	8.03 [0.316]
500M	12.70 [0.500]	12.70 [0.500]	10.03 [0.395]	10.03 [0.395]
1250M	15.70 [0.618]	15.70 [0.618]	13.03 [0.513]	13.03 [0.513]
2500M	23.83 [0.938]	22.28 [0.877]	20.78 [0.818]	19.23 [0.757]
5000M	39.14 [1.541]	36.93 [1.454]	36.09 [1.421]	33.88 [1.334]

These dimensions and screws are the same for all 5 probes

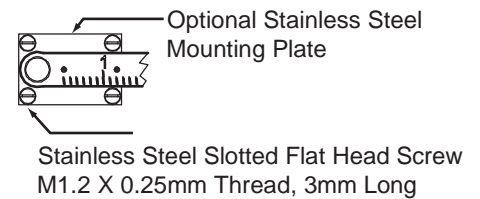
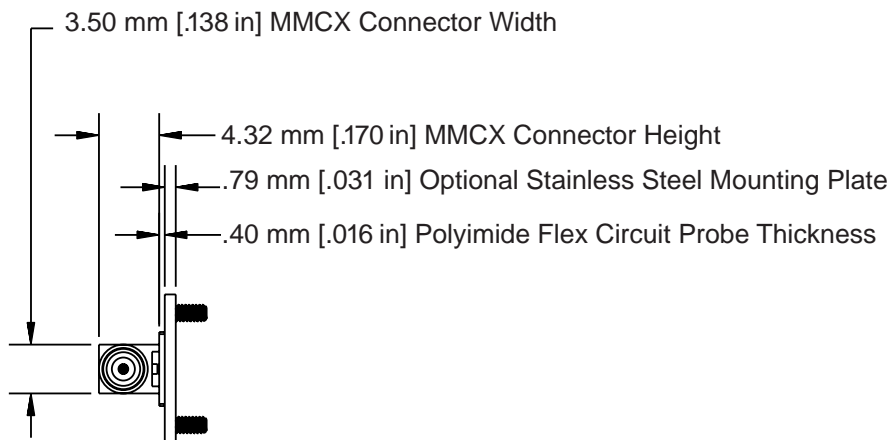
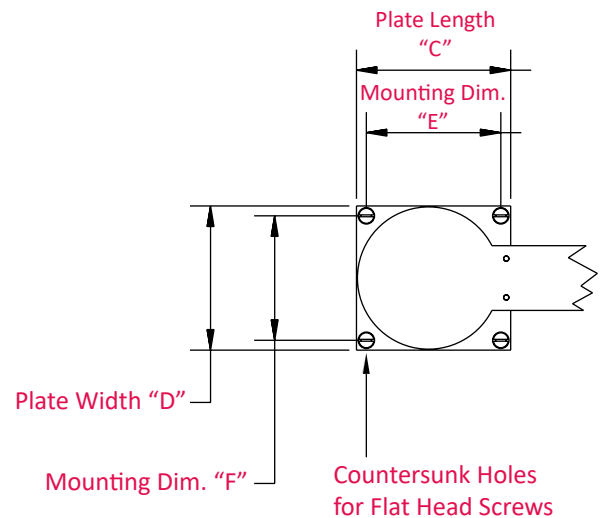

Cables

MMCX to SMA: 8000-6371-4xx

xx = length in meters, for example 2.2 meters = 422

MMCX to BNC: 8000-6401-4xx

Push Pull Flat Probes for Ungrounded Targets

Standard capacitive sensors require the target to be electrically grounded. Current flows from the probe face to the target and back to the amplifier to complete the circuit. The capacitance between probe and target is proportional to the distance and converted to a 0-10V output from the amplifier. The measurement of electrically grounded targets can be, however, affected by changes in the electrical conductivity or ground path of the target.

To eliminate the effects of these variations, MTI developed a unique version of the Accumeasure sensor called the push-pull. In this design each probe consists of two capacitance sensors, built into one probe body. Each sensor is driven at the same voltage; however, there is a 180 degree phase shift between signals. This shift allows the current path to travel across the target surface rather than through the target to ground, eliminating any inaccuracies created by poorly grounded targets.



MTI's AFP-250MD-CTR/PP flat capacitance probe can operate on ungrounded targets.



General Specifications for Flat Push Pull Probes

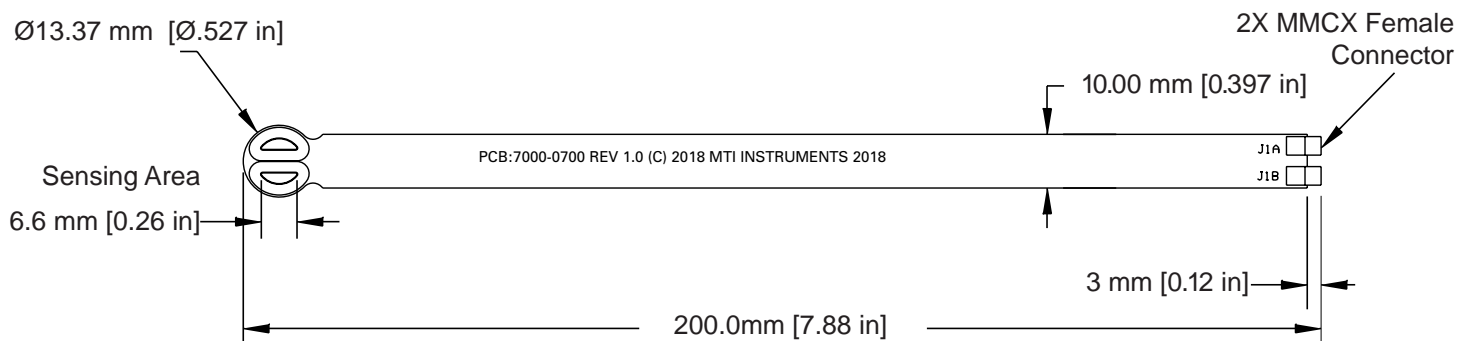

AFP-250MD-CTR/PP PUSH PULL PROBE FOR UNGROUNDED TARGET

Base Range		Base Sensitivity		Base Min. Range		Spot Size		Linearity	Model	AFP-250MD-CTR/PP
μm	<i>mils</i>	$\mu\text{m}/\text{V}$	<i>mils/V</i>	μm	<i>mils</i>	mm	<i>Inch</i>	% FSR		
250	10	0.025	0.001	25	1.0	8.9 x 6.6	.35 x .26	0.02%	Range Extension	1X to 7X

Extended range = Base Sensitivity X Base Extension

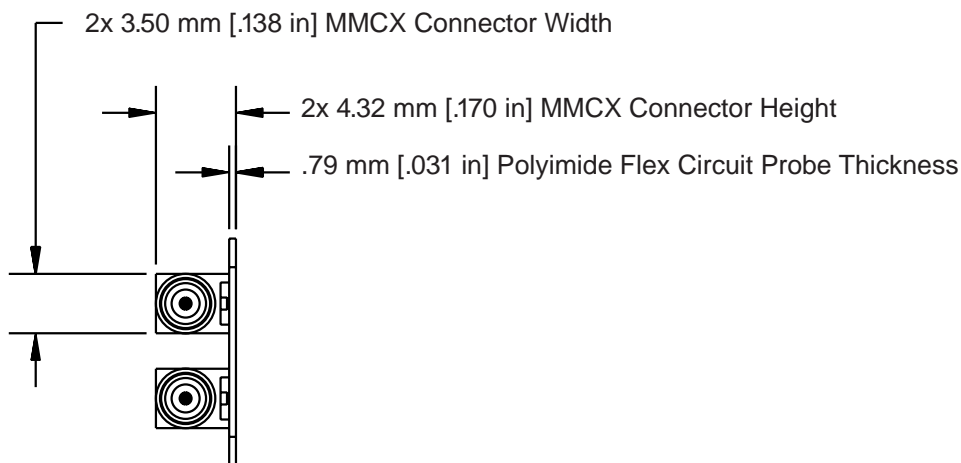

Cables

MMCX to SMA: 8000-6371-4xx

xx = length in meters, for example 2.2 meters = 422

MMCX to BNC: 8000-6401-4xx

Probe Recommended Stand-off Ranges

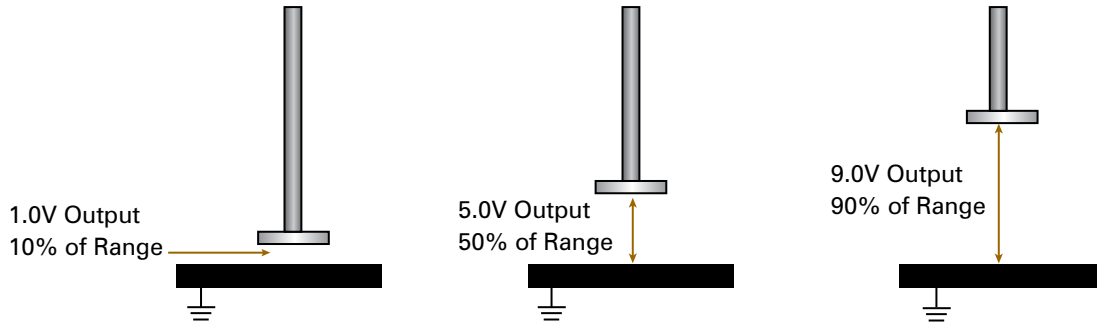

Probe Specifications

Cable and Probe Temperature Rating:	-65°C to 150°C
Connector Temperature Rating:	-65°C (-85°F) to 85°C (185°F)
Accuracy ¹ :	±0.01%FSR or better, of range when probe and amplifier are calibrated to a known standard at X1 range extension.
Probe and Cable Interchangeability:	Accurate to within ±0.2% at X1 range extension without recalibration.
Pressure Rating Standard:	1400 (2000 psig)
Material:	Polyimide, no active internal electronics
Cable Length ²	***** extension cables. Connector type probes require selection of cable assembly upon ordering

¹As range extension increases linearity decreases. Probe resolution is approximately .000085 vHz FSR. Noise increases proportionally to range extension selected. x2 range extension will decrease resolution by 2X. Increasing the averaging function will decrease noise but also decreases the amplifiers bandwidth (consult users manual). Increasing the probe's cable length will also increase system noise and decrease resolution proportionally.

²Contact factory to increase ILA/ILR/PSR cable to non-standard cable lengths. Or purchase the optional special low-noise probe extension cable (information on brochure), extension cables do not require an adapter as they are male to female SMA connectors.

Optional Accessories

Description	Product Number
KD-CH-4D Calibration Fixture	8000-6952

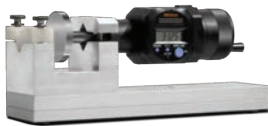

KD-CH-4D calibrator

A precision fixture that secures a non-contact displacement sensor and accurately varies the position of a target relative to the sensor. It provides an excellent means of obtaining calibration data at the user's facility.

Gap Applications

Flat probes can be bonded back to back and inserted into a handle (8000-6443) or used stand-alone to make thin gap probes. Additionally, a shim may be bonded between the probes for added stiffness.

Contact MTI sales with your requirements for measuring roller or die slots.

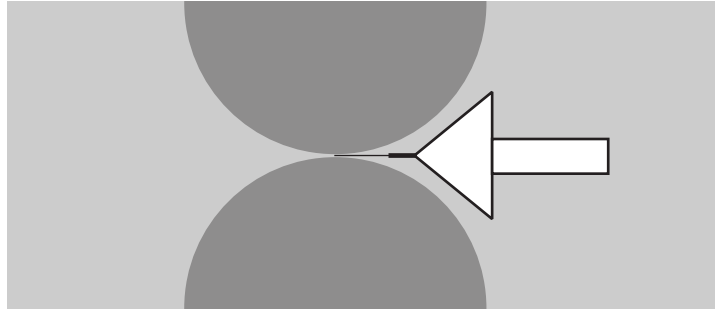

Measure Roller gap with a hand-held gap probe.



MTI has custom capability to design and manufacture a variety of probes to suit unique applications. This flat probe design capability allows for relatively inexpensive probes when produced in quantity.



MTI's back-to-back push-pull probes can work as gap probes on ungrounded targets. These probes require a four channel amplifier such as the Digital Accumeasure D400 to operate.

Unmounted Probe Bonding Instructions

The probes can also be bonded back to back on a thin SS tab for insertion into slots or gaps.

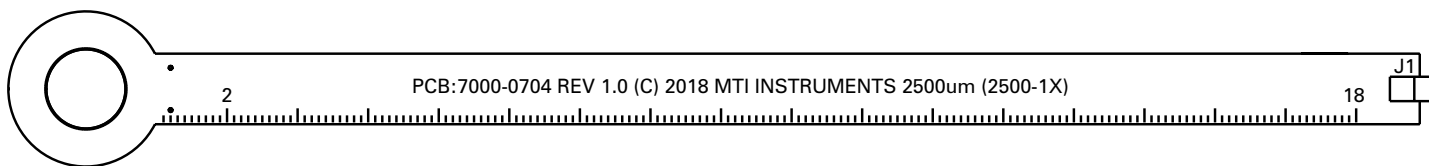

- Probe back and surface prep - lightly roughen surfaces with scotch bright or similar sandpaper.
- MasterBond EP21TCHT-1 or Loctite Ablestik 104, very thin layer (double-sided tape is not recommended).
- Clamp or weight the probe to ensure flat attachment.
- Cover MMCX connector with heat shrink tube. Do not let the MMCX connector body touch grounded surfaces or objects as it's a driven guard.

Compatible with



(MMCX male to SMA male)

* Other lengths available as custom option

ACCUMEASURE™ D series CAPACITANCE AMPLIFIER

True Direct Digital Capacitive Displacement Sensor
Up to 0.01% FSR Linearity

Description	Product Number
1 meter cable extension	8000-6371-410
2 meter cable extension	8000-6371-420
4 meter cable extension	8000-6371-440

MTI Instruments, Inc.

325 Washington Avenue Extension

Albany, NY 12205-5505

PH: +1-518-218-2550

OR USA TOLL FREE: 1-800-342-2203

FAX: +1- 518-218-2506

EMAIL: sales@mtiinstruments.com

www.mtiinstruments.com

mtiinstruments